



First Grade first Term English EXAM

Full Name :

School year (2023/2024)

Class :

Activity one: Color the items red, blue, yellow and orange.

_This is a pencil. It's red.

_This is a pen. It's orange.

_This is a book. It's blue.



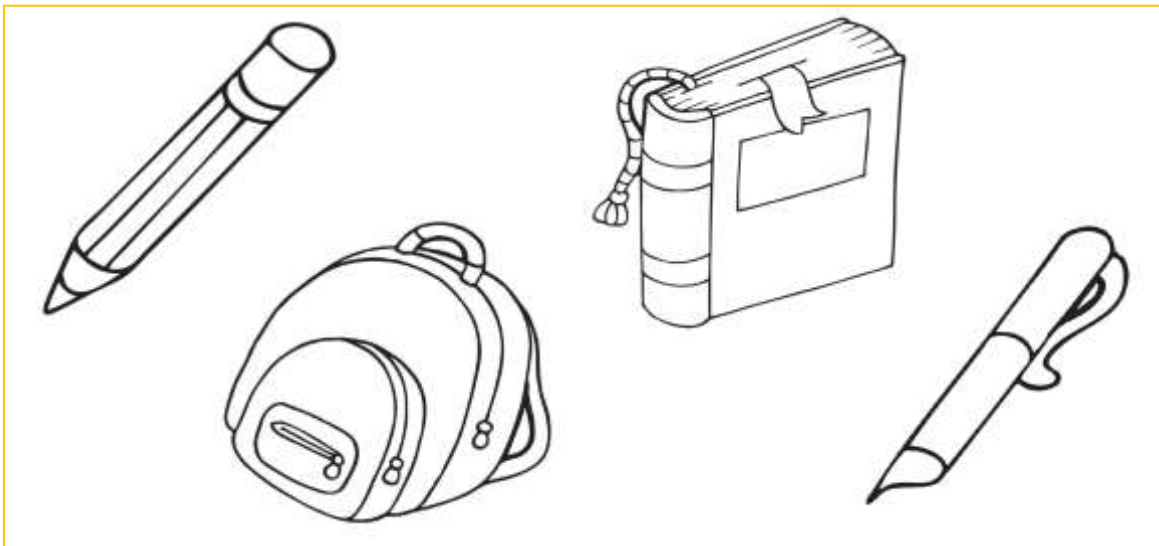



_This is a bag. It's yellow.





Activity two: Read and match.

Triangle	
Circle	
Square	

Activity three: Count and match.

	5
	1
	4
	2
	7
	3
	6

Activity four: Circle the correct answer.

		
Stand up	Stand up	Clap your hands
Clap your hands	Sit down	Sit down



Correction

1/Activity one: Color the items red, blue, yellow and orange. (2pts)

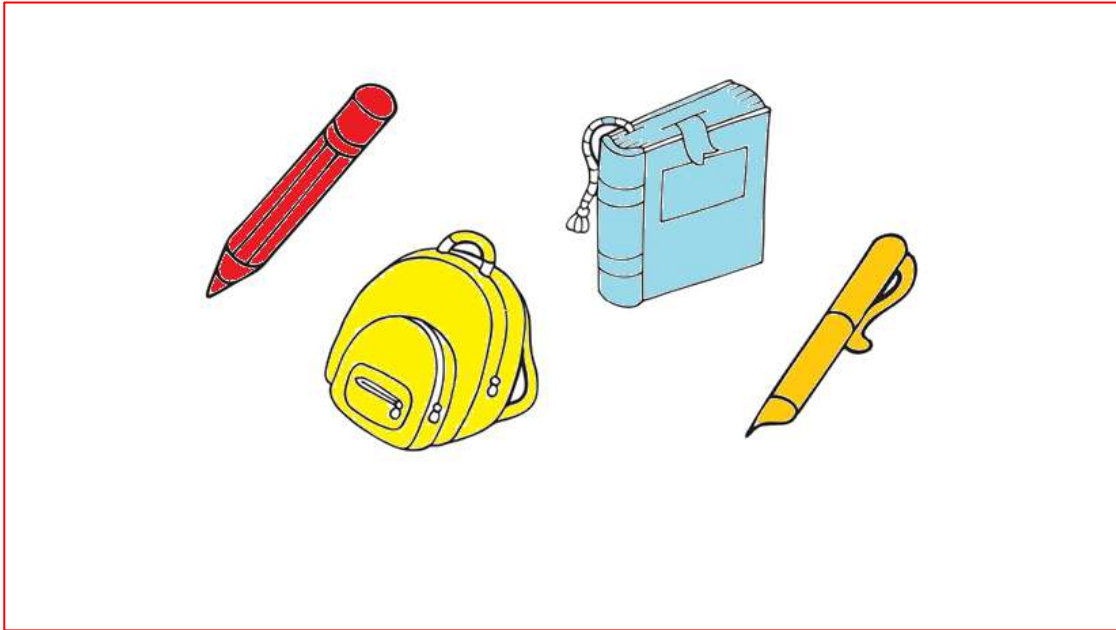

2/Activity two: Read and match. (3pts)

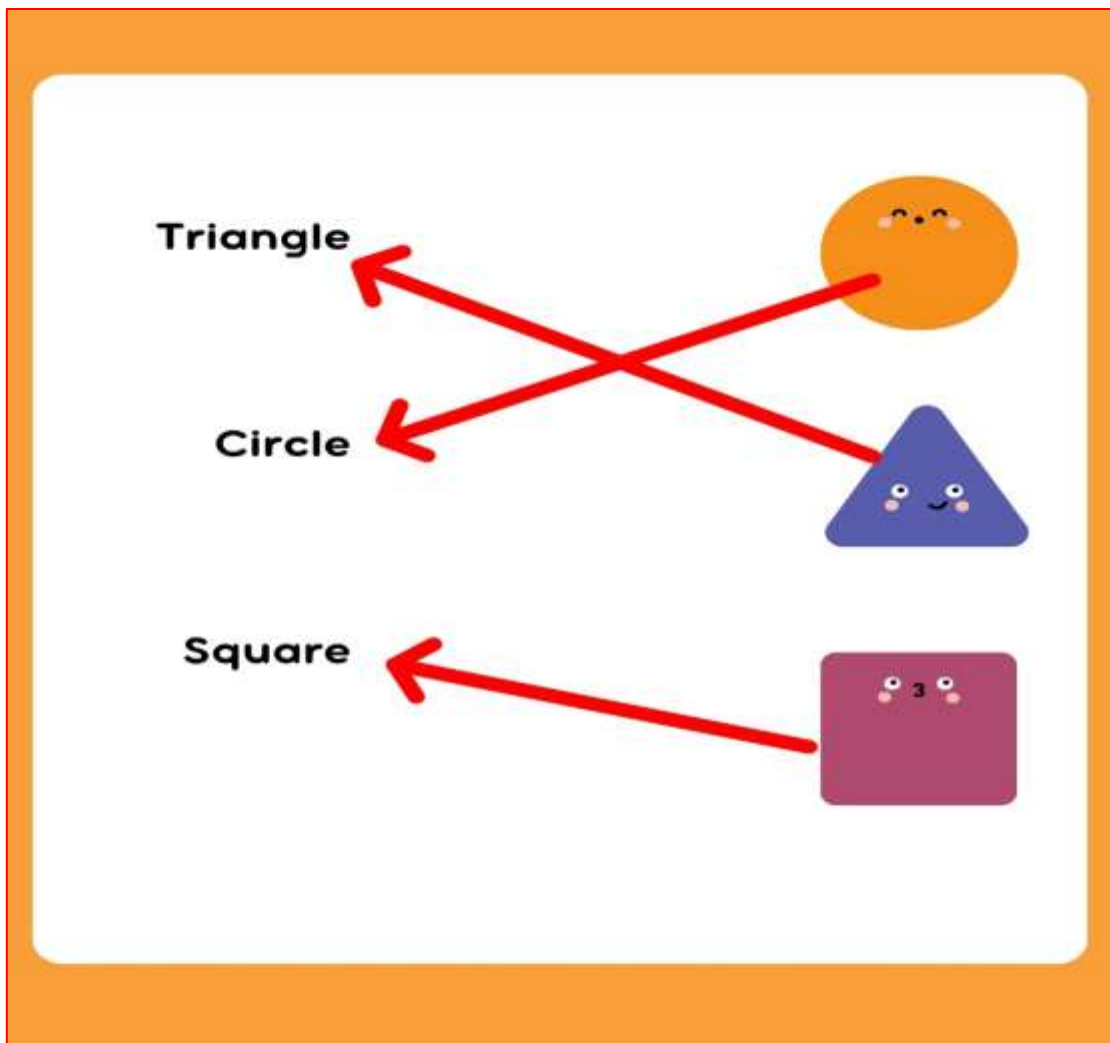

3/Activity three: Count and match. (3,5pts)

7 apples, 6 watermelon slices, 5 boys, 4 balloons, 3 cars, 1 airplane, 2 beach balls.

Numbers: 5, 1, 4, 2, 7, 3, 6.

4/Activity four: Circle the correct answer. (1,5pts)

Stand up, Clap your hands (circled)

Stand up (circled), Sit down

Clap your hands, Sit down (circled)